

# AD SERIES

Electronic Solutions  
Design & Manufacture



Octab Range - 3288



Low cost, highly reliable professional tablets for deploying Android. Designed for 24/7 Commercial use. Compact & rugged. Touchscreen as standard. Also available with no touch.

## Key Features



Android

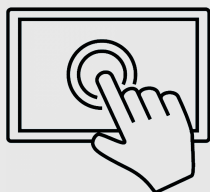

Capacitive  
Touchscreen



Wifi Enabled



24 Hour  
Commercial Use

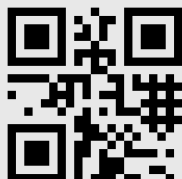

+44(0)870 005 5520

UK Head Office: Unit 49 Eldon Way,  
Paddock Wood, Kent, TN12 6BE

eva2@adseries.com



OEM available



### Octab Range - 3288

## Overview

Low cost, highly reliable professional tablets for deploying Android. Designed for 24/7 Commercial use. Compact & rugged. Touchscreen as standard. Also available with no touch.

## Markets

Our Android tablets are designed to address retail and commercial sector applications unmatched by consumer tablets – robust, highly reliable and in an unbeatable range of sizes. They cater for both simple and more complex apps

## Benefits

- Compact & rugged.
- Rockchip 3288
- Highly reliable, designed for 24/7 commercial use
- Auto-on
- Smaller screen sizes available
- Available for customisation and economical for larger production

## Key Features



Android



24 Hour  
Commercial Use

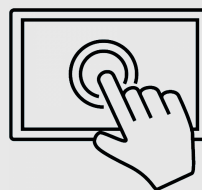

Capacitive  
Touchscreen

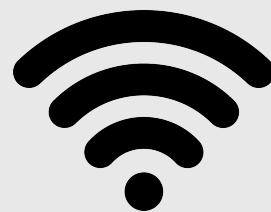

Wifi Enabled

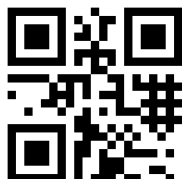

+44(0)870 005 5520

UK Head Office: Unit 49 Eldon Way,  
Paddock Wood, Kent, TN12 6BE

eva2@adseries.com

Product Details				
Product Code	OCTAB101P-T-2	OCTAB116P-T-2	OCTAB141P-T-2	OCTAB156P-T-2
Screen size				
Screen Size	10.1"	11.6"	14.1"	15.6"
Panel				
Resolution	1280x800	1920x1080	1920x1080	1920x1080
Aspect Ratio	16:9	16:9	16:9	16:9
Viewing Angle	89x89x89x89	89x89x89x89	85x85x85x85	85x85x85x85
Active Area	216.96x135.6	256.32x144.18	309.21x173.98	344.16x193.59
Brightness	250-600	250-600	250-600	250-600
Contrast	900:1	800:1	800:1	800:1
Touch				
Touch Technology	Capacitive Touch (G+G optional)	Capacitive Touch (G+G optional)	Capacitive Touch (G+G optional)	Capacitive Touch (G+G optional)
Touch Points	10	10	10	10
Hardware & OS				
CPU	Quad Core cortex A17, 1.8G, RK3288	Quad Core cortex A17, 1.8G, RK3288	Quad Core cortex A17, 1.8G, RK3288	Quad Core cortex A17, 1.8G, RK3288
RAM	2Gb	2Gb	2Gb	2Gb
Storage	16Gb	16Gb	16Gb	16Gb
OS	Android version 8.1	Android version 8.1	Android version 8.1	Android version 8.1
Power				
Power Consumption	24	24	36	36
Power Requirement	12V 2A	12V 2A	12V 3A	12V 3A (2A)
Power Jack	USB Host 2.0 Interface 6	USB Host 2.0 Interface 6	USB Host 2.0 Interface 6	USB Host 2.0 Interface 6
Connections				
USB Device	Yes	Yes	Yes	Yes
USB Host	2.1mm	2.1mm	2.1mm	2.1mm
HDMI	HDMI Output	HDMI Output	HDMI Output	HDMI Output
Wifi	WiFi 2.4 GHz 802.11b/g/n (optional 5GHz 802.11a)	WiFi 2.4 GHz 802.11b/g/n (optional 5GHz 802.11a)	WiFi 2.4 GHz 802.11b/g/n (optional 5GHz 802.11a)	WiFi 2.4 GHz 802.11b/g/n (optional 5GHz 802.11a)
Ethernet	No	No	No	No
Bluetooth	Bluetooth 4.0	Bluetooth 4.0	Bluetooth 4.0	Bluetooth 4.0
3G dongle	3G USB dongle ext.	3G USB dongle ext.	3G USB dongle ext.	3G USB dongle ext.
Card Slot	SD,Support up to 32GB	SD,Support up to 32GB	SD,Support up to 32GB	SD,Support up to 32GB
Earphone	3.5mm earphone	3.5mm earphone	3.5mm earphone	3.5mm earphone
Media				
Video Format	WMV, AVI, FLV, RM, RMVB, MPEG, TS, MP4, etc. RK3288: support up to 1080p	WMV, AVI, FLV, RM, RMVB, MPEG, TS, MP4, etc. RK3288: support up to 1080p	WMV, AVI, FLV, RM, RMVB, MPEG, TS, MP4, etc. RK3288: support up to 1080p	WMV, AVI, FLV, RM, RMVB, MPEG, TS, MP4, etc. RK3288: support up to 1080p
Image Format	BMP, JPEG, PNG, GIF	BMP, JPEG, PNG, GIF	BMP, JPEG, PNG, GIF	BMP, JPEG, PNG, GIF
Audio Format	MP3/WMA/AAC	MP3/WMA/AAC	MP3/WMA/AAC	MP3/WMA/AAC
Optional				
Camera	2.0M/P Front	2.0M/P Front	2.0M/P Front	2.0M/P Front
Accessories				
Included In Box	Power Supply	Power Supply	Power Supply	Power Supply
General Information				
Speakers	2x 2W	2x 2W	2x 2W	2x 3W
Colour	Black	Black	Black	Black
Language	Multi-language	Multi-language	Multi-language	Multi-language
Working Temperature	0-50 degrees	0-50 degrees	0-50 degrees	0-50 degrees
Unit Size (LxWxHmm)	260.54x178.54x27.50	284.65x182.25x27.48	355x228x?	403.76x252.76x33.50
Package Size (LxWxHmm)	286x256x74	350x25875	373x320x78	480x295x88
Vesa Mounting (mm)	75x75	75x75	75x75	75x75
Unit Weight (kg)	0.65	0.44	0.95	1.36
Package Weight (kg)	0.82	0.76	1.4	2.25



+44(0)870 005 5520

UK Head Office: Unit 49 Eldon Way,  
Paddock Wood, Kent, TN12 6BE

eva2@adseries.com

Product Details					
Product Code	OCTAB173P-T-2	OCTAB215P-T-2	OCTAB238P-T-2	OCTAB270P-T-2	OCTAB320P-T-2
<b>Screen size</b>					
Screen Size	17.3"	21.5"	23.8"	27"	32"
<b>Panel</b>					
Resolution	1920x1080	1920x1080	1920x1080	1920x1080	1920x1080
Aspect Ratio	16:9	16:9	16:9	16:9	16:9
Viewing Angle	85x85x85x85	89x89x89x89	89x89x89x89	89x89x89x89	89x89x89x89
Active Area	381.89x214.81	474.64x268.11	527.04x296.46	597.6x336.15	698.4x392.85
Brightness	250-600	250-600	250-600	250-600	250-600
Contrast	800:1	3000:1	1000:1	3000:1	1000:1
<b>Touch</b>					
Touch Technology	Capacitive Touch (G+G optional)	Capacitive Touch (G+G optional)	Capacitive Touch (G+G optional)	Capacitive Touch (G+G optional)	Capacitive Touch (G+G optional)
Touch Points	10	10	10	10	10
<b>Hardware &amp; OS</b>					
CPU	Quad Core cortex A17, 1.8G, RK3288	Quad Core cortex A17, 1.8G, RK3288	Quad Core cortex A17, 1.8G, RK3288	Quad Core cortex A17, 1.8G, RK3288	Quad Core cortex A17, 1.8G, RK3288
RAM	2Gb	2Gb	2Gb	2Gb	2Gb
Storage	16Gb	16Gb	16Gb	16Gb	16Gb
OS	Android version 8.1	Android version 8.1	Android version 8.1	Android version 8.1	Android version 8.1
<b>Power</b>					
Power Consumption	36	36	48	48	60
Power Requirement	12V 3A	12V 3A	12V 4A	12V 4A	12V 5A
Power Jack	USB Host 2.0 Interface 6	USB Host 2.0 Interface 6	USB Host 2.0 Interface 6	USB Host 2.0 Interface 6	USB Host 2.0 Interface 6
<b>Connections</b>					
USB Device	Yes	Yes	Yes	Yes	Yes
USB Host	2.1mm	2.1mm	2.1mm	2.1mm	2.1mm
HDMI	HDMI Output	HDMI Output	HDMI Output	HDMI Output	HDMI Output
Wifi	WiFi 2.4 GHz 802.11b/g/n (optional 5GHz 802.11a)	WiFi 2.4 GHz 802.11b/g/n (optional 5GHz 802.11a)	WiFi 2.4 GHz 802.11b/g/n (optional 5GHz 802.11a)	WiFi 2.4 GHz 802.11b/g/n (optional 5GHz 802.11a)	WiFi 2.4 GHz 802.11b/g/n (optional 5GHz 802.11a)
Ethernet	No	No	No	Yes	Yes
Bluetooth	Bluetooth 4.0	Bluetooth 4.0	Bluetooth 4.0	Bluetooth 4.0	Bluetooth 4.0
3G dongle	3G USB dongle ext.	3G USB dongle ext.	3G USB dongle ext.	3G USB dongle ext.	3G USB dongle ext.
Card Slot	SD, Support up to 32GB	SD, Support up to 32GB	SD, Support up to 32GB	SD, Support up to 32GB	SD, Support up to 32GB
Earphone	3.5mm earphone	3.5mm earphone	3.5mm earphone	3.5mm earphone	3.5mm earphone
<b>Media</b>					
Video Format	WMV, AVI, FLV, RM, RMBV, MPEG, TS, MP4, etc. RK3288: support up to 1080p	WMV, AVI, FLV, RM, RMBV, MPEG, TS, MP4, etc. RK3288: support up to 1080p	WMV, AVI, FLV, RM, RMBV, MPEG, TS, MP4, etc. RK3288: support up to 1080p	WMV, AVI, FLV, RM, RMBV, MPEG, TS, MP4, etc. RK3288: support up to 1080p	WMV, AVI, FLV, RM, RMBV, MPEG, TS, MP4, etc. RK3288: support up to 1080p
Image Format	BMP, JPEG, PNG, GIF	BMP, JPEG, PNG, GIF	BMP, JPEG, PNG, GIF	BMP, JPEG, PNG, GIF	BMP, JPEG, PNG, GIF
Audio Format	MP3/WMA/AAC	MP3/WMA/AAC	MP3/WMA/AAC	MP3/WMA/AAC	MP3/WMA/AAC
<b>Optional</b>					
Camera	2.0M/P Front	2.0M/P Front	N/A (optional)	N/A (optional)	N/A (optional)
<b>Accessories</b>					
Included In Box	Power Supply	Power Supply	Power Supply	Power Supply	Power Supply
<b>General Information</b>					
Speakers	2x 3W	2x 3W	2x 5W	2x 5W	2x 5W
Colour	Black	Black	Black	Black	Black
Language	Multi-language	Multi-language	Multi-language	Multi-language	Multi-language
Working Temperature	0-50 degrees	0-50 degrees	0-50 degrees	0-50 degrees	0-50 degrees
Unit Size (LxWxHmm)		539.11x332.21x39.75	595.5x363.1x43.6	660.27x400x41.03	763.77x457.21x47.02
Package Size (LxWxHmm)		582x430x89	660x455x115	725x490x120	860x555x135
Vesa Mounting (mm)	100x100	100x100	100x100	75x75, 100x100	75x75, 100x100
Unit Weight (kg)		2.84	5	6.9	9.45
Package Weight (kg)		3.75	6.5	8.85	10.52



## Technical Drawings Index Octab Range - 3288

Screen Size

10.1"

11.6"

14.1"

15.6"

17.3"

21.5"

23.8"

27"

32"

Page number

6

7

8

9

10

11

12

13

14

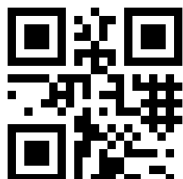

# AD SERIES

## Specifications

### Octab 10.1" - OCTAB101P-T-2

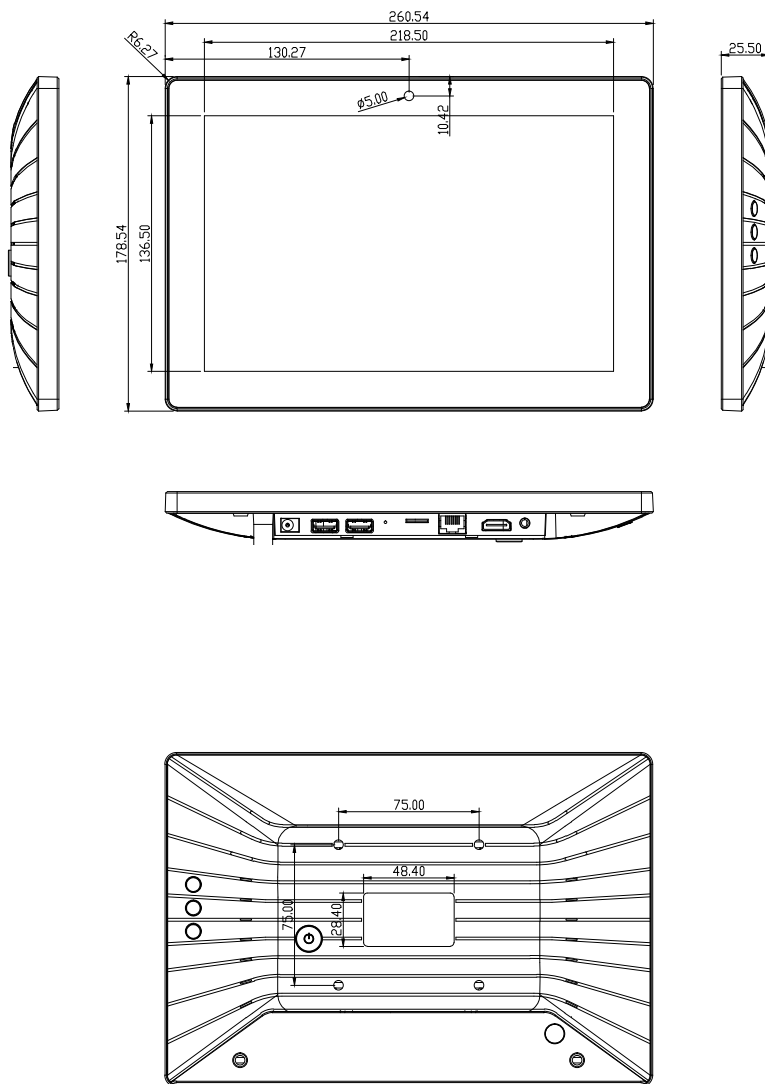

\*Specifications are typical and subject to change.

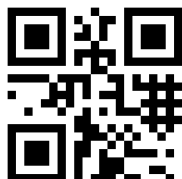

+44(0)870 005 5520

UK Head Office: Unit 49 Eldon Way,  
Paddock Wood, Kent, TN12 6BE

eva2@adseries.com

# AD SERIES

## Specifications

### Octab 11.6" - OCTAB116P-T-2

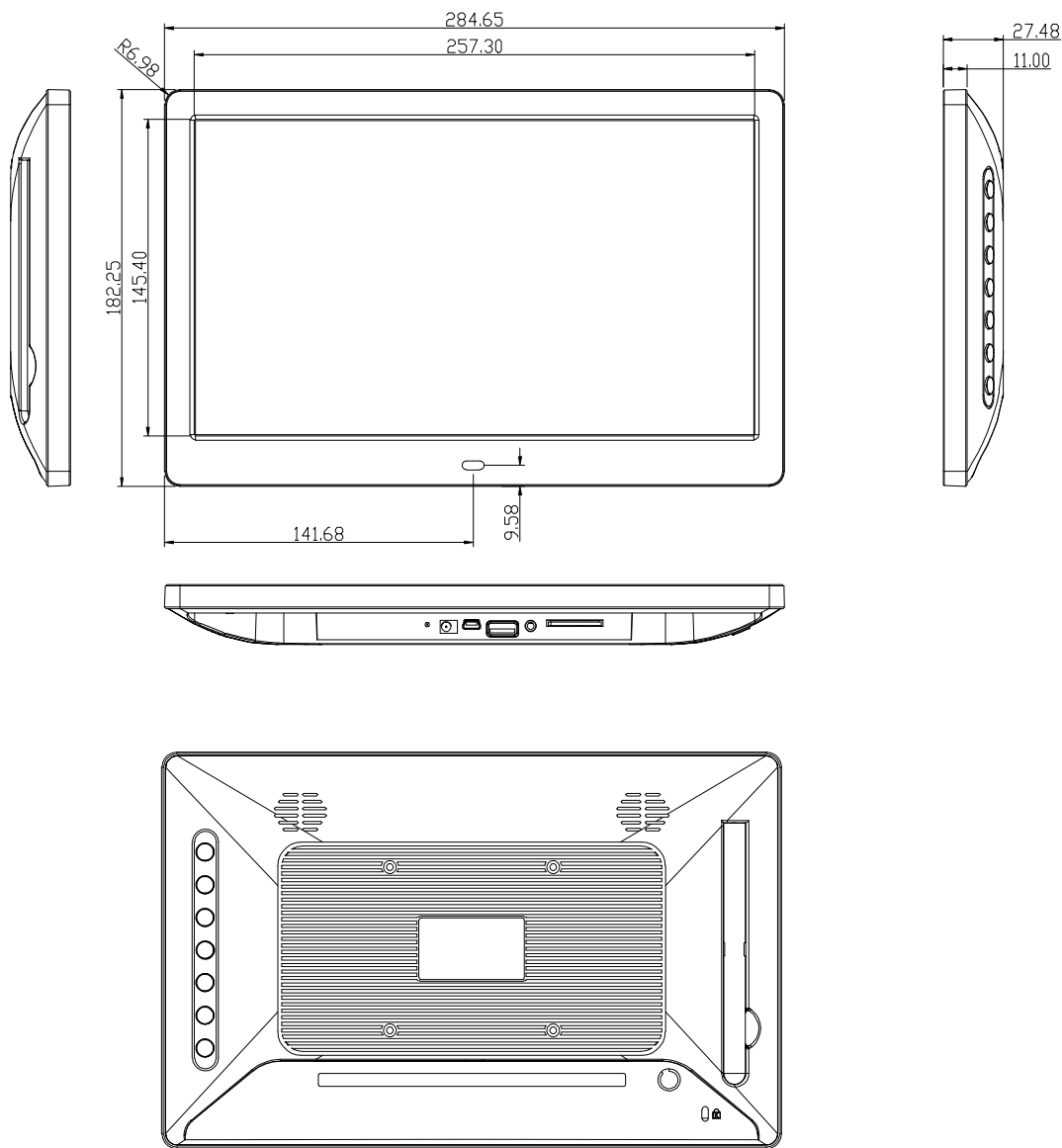

\*Specifications are typical and subject to change.

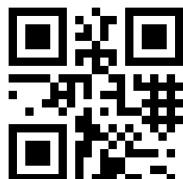

+44(0)870 005 5520

UK Head Office: Unit 49 Eldon Way,  
Paddock Wood, Kent, TN12 6BE

eva2@adseries.com

# AD SERIES

## Specifications

### Octab 14.1" - OCTAB141P-T-2

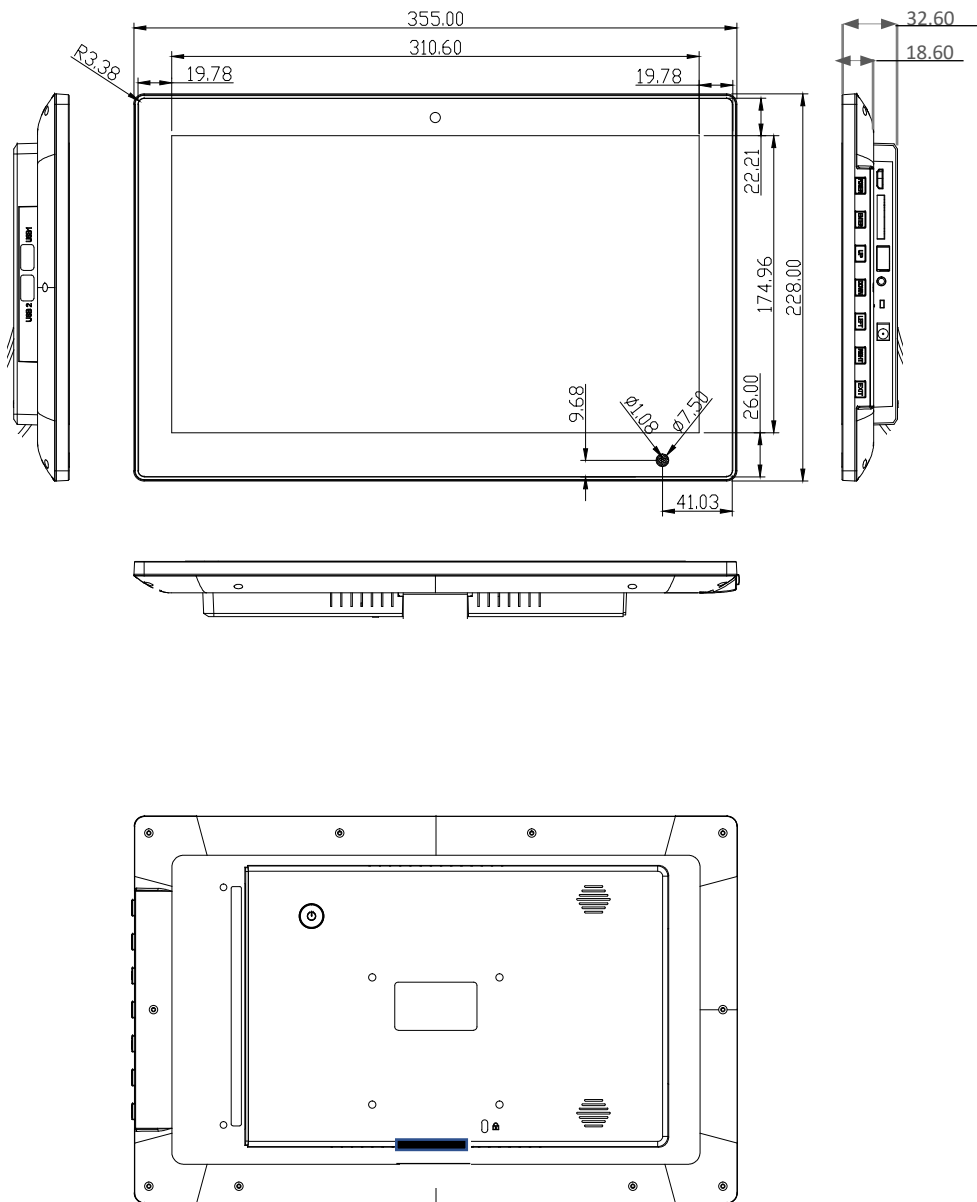

\*Specifications are typical and subject to change.

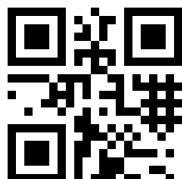

+44(0)870 005 5520

UK Head Office: Unit 49 Eldon Way,  
Paddock Wood, Kent, TN12 6BE

eva2@adseries.com



# AD SERIES

## Specifications

### Octab 15.6" - OCTABI56P-T-2

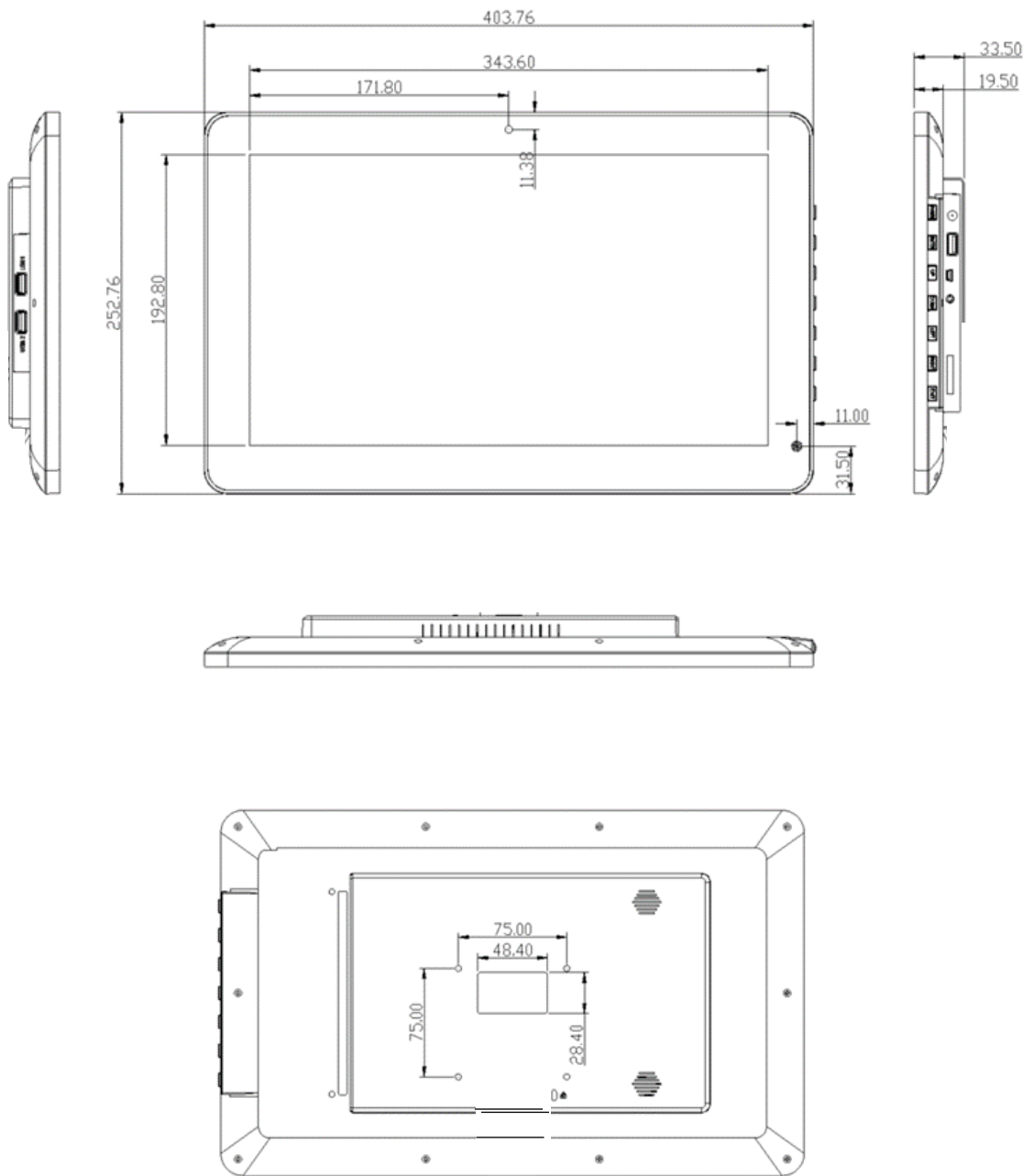

\*Specifications are typical and subject to change.

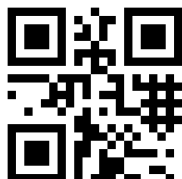

+44(0)870 005 5520

UK Head Office: Unit 49 Eldon Way,  
Paddock Wood, Kent, TN12 6BE

eva2@adseries.com

# AD SERIES

## Specifications

### Octab 17.3" - OCTAB173P-T-2

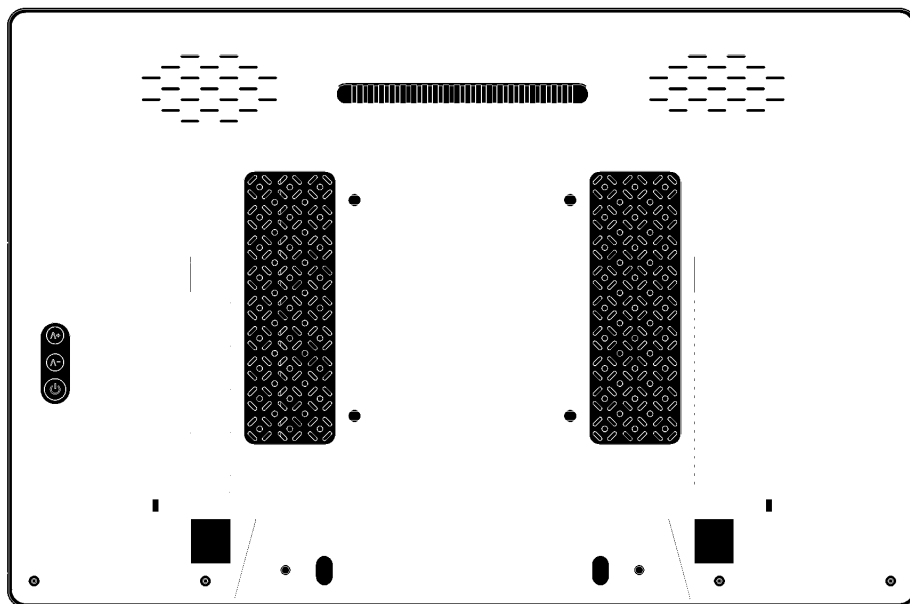
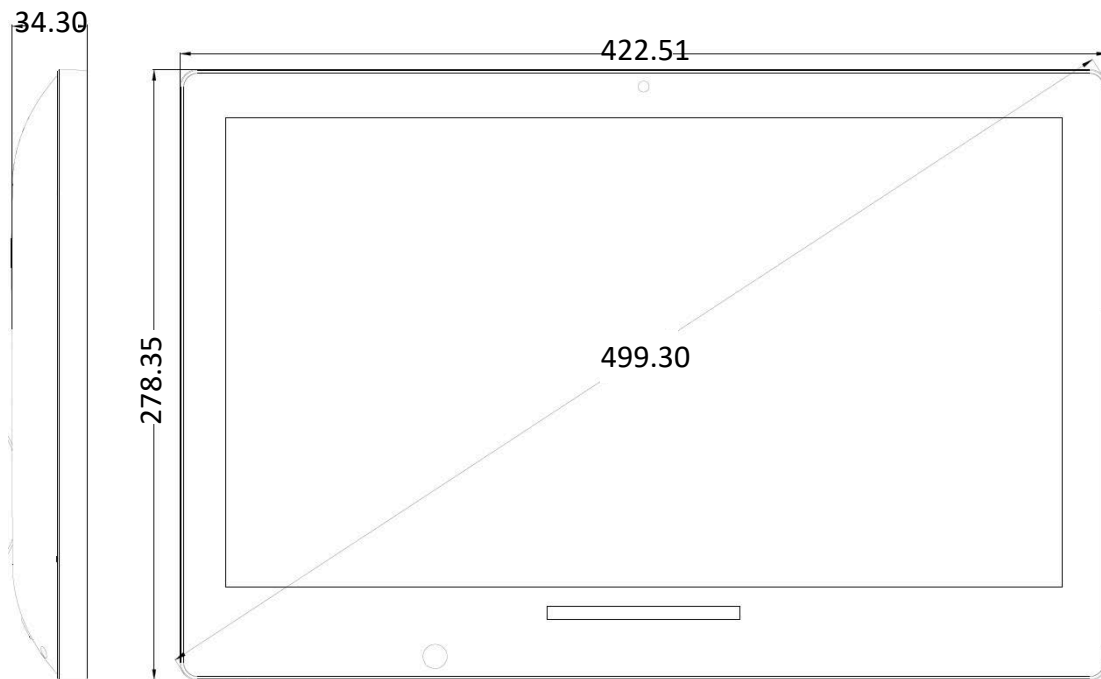

\*Specifications are typical and subject to change.

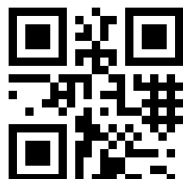

+44(0)870 005 5520

UK Head Office: Unit 49 Eldon Way,  
Paddock Wood, Kent, TN12 6BE

eva2@adseries.com

# AD SERIES

## Specifications

### Octab 21.5" - OCTAB215P-T-2

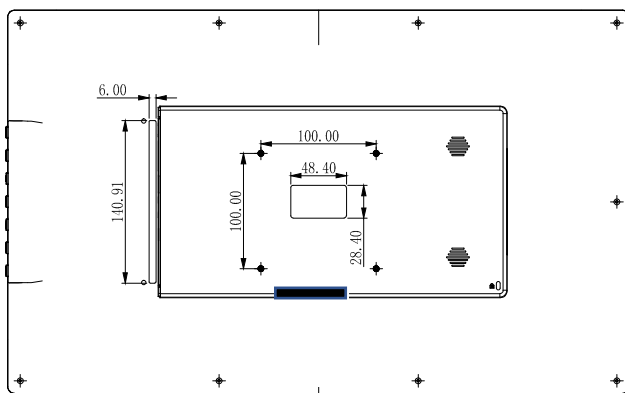
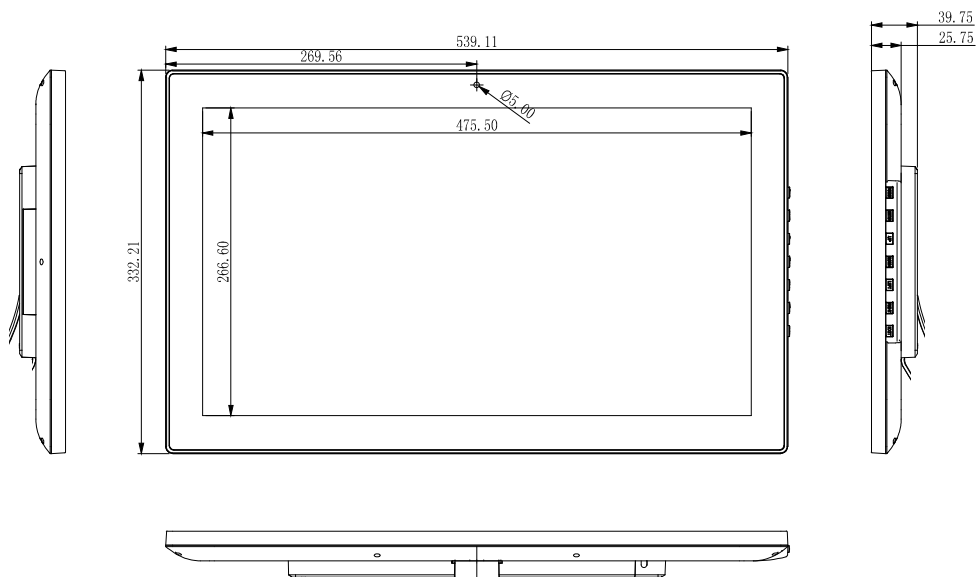

\*Specifications are typical and subject to change.

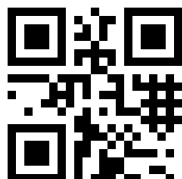

+44(0)870 005 5520

UK Head Office: Unit 49 Eldon Way,  
Paddock Wood, Kent, TN12 6BE

eva2@adseries.com

# AD SERIES

## Specifications

### Octab 23.8" - OCTAB238P-T-2

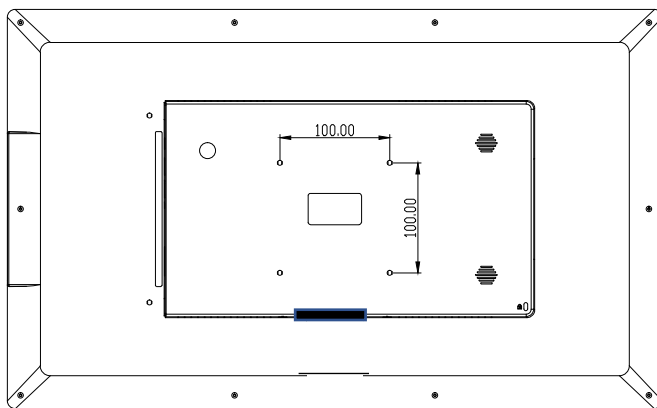
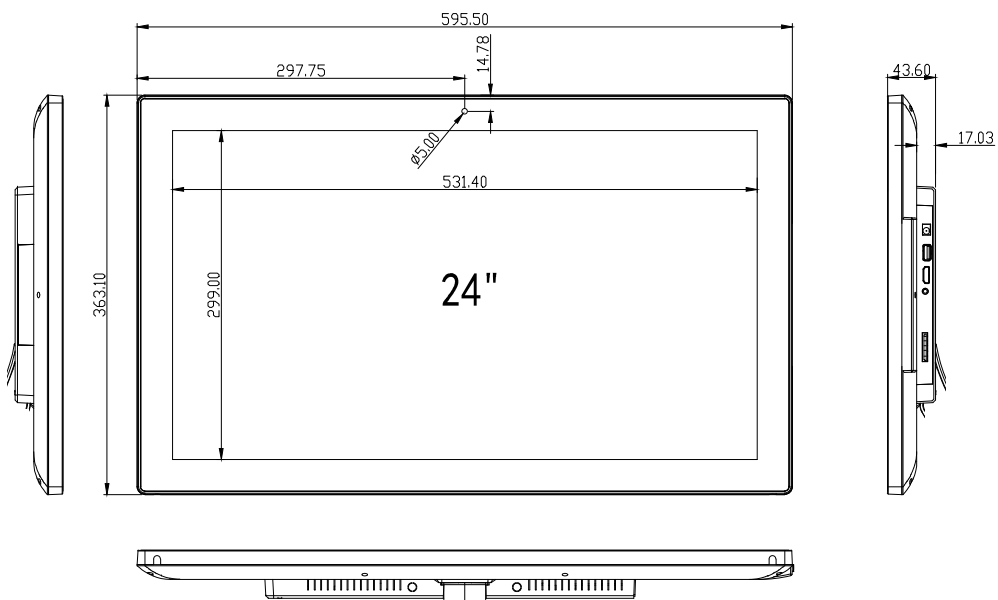

\*Specifications are typical and subject to change.

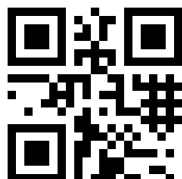

+44(0)870 005 5520

UK Head Office: Unit 49 Eldon Way,  
Paddock Wood, Kent, TN12 6BE

eva2@adseries.com

# AD SERIES

## Specifications

### Octab 27" - OCTAB270P-T-2

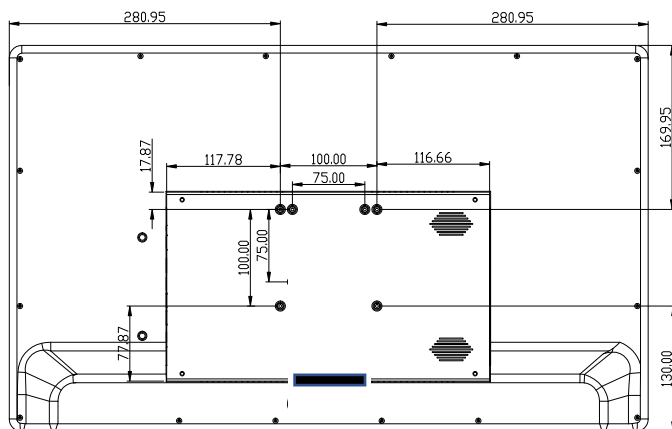
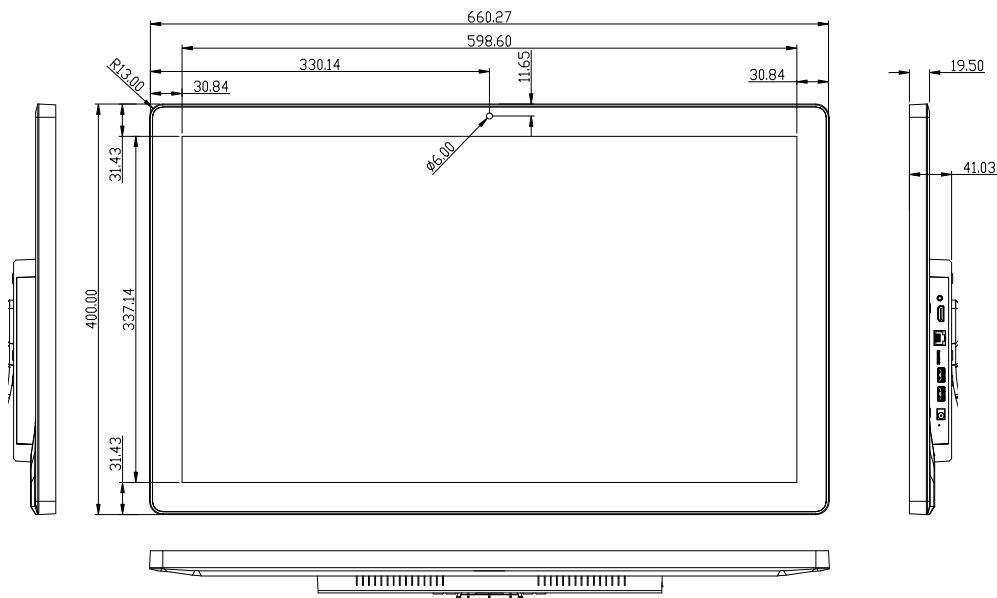

\*Specifications are typical and subject to change.

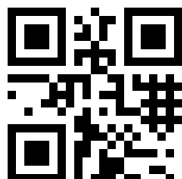

+44(0)870 005 5520

UK Head Office: Unit 49 Eldon Way,  
Paddock Wood, Kent, TN12 6BE

eva2@adseries.com

# AD SERIES

## Specifications

### Octab 32" - OCTAB320P-T-2

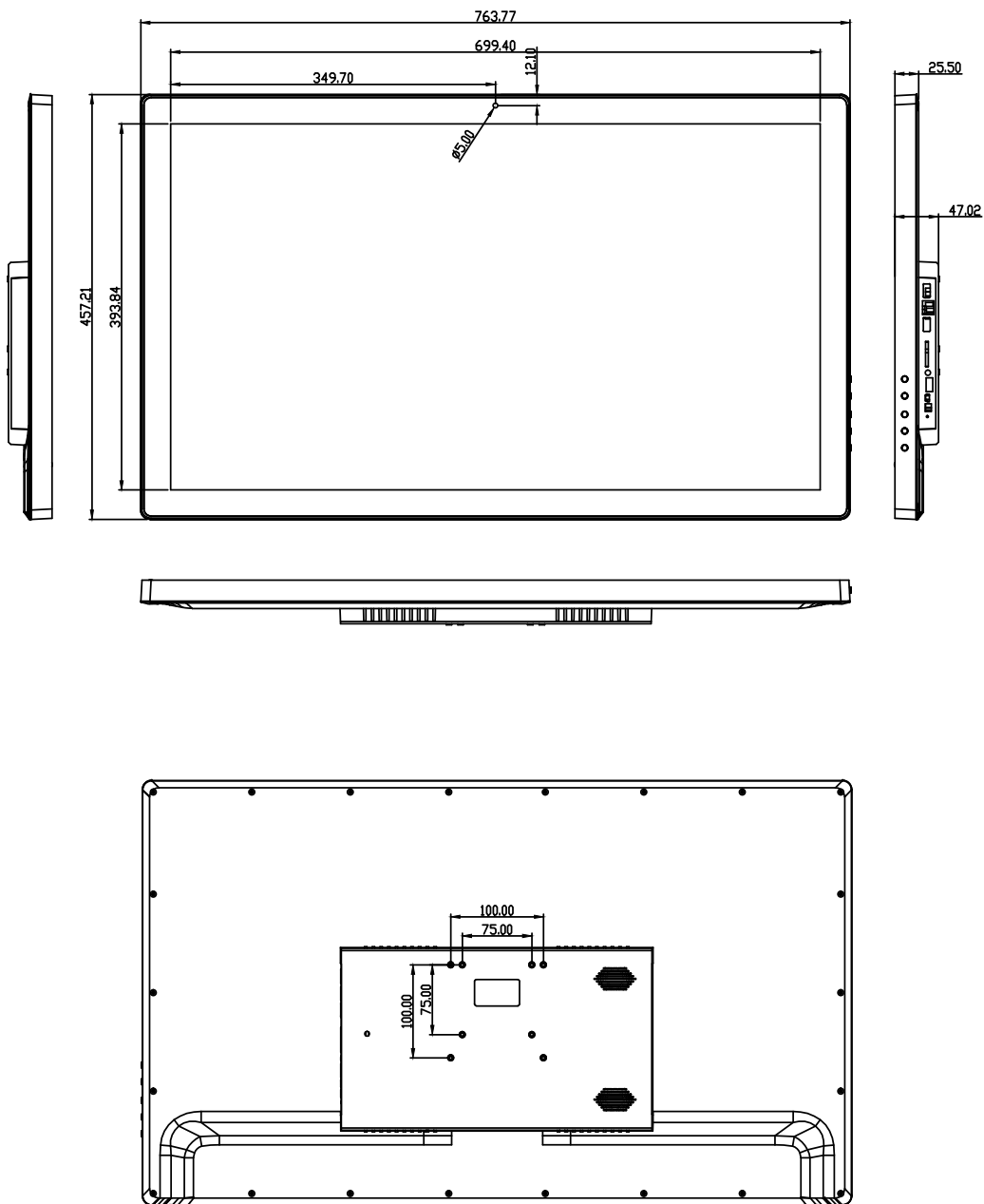

\*Specifications are typical and subject to change.

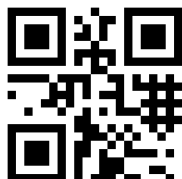

+44(0)870 005 5520

UK Head Office: Unit 49 Eldon Way,  
Paddock Wood, Kent, TN12 6BE

eva2@adseries.com